

P/N. FD537
 ALL DIMENSIONS IN MM UNLESS STATED
 THE CONTENTS OF THIS DRAWING ARE COPYRIGHT AND SHOULD NOT BE REPRODUCED WITHOUT THE PERMISSION OF DJH ENGINEERING

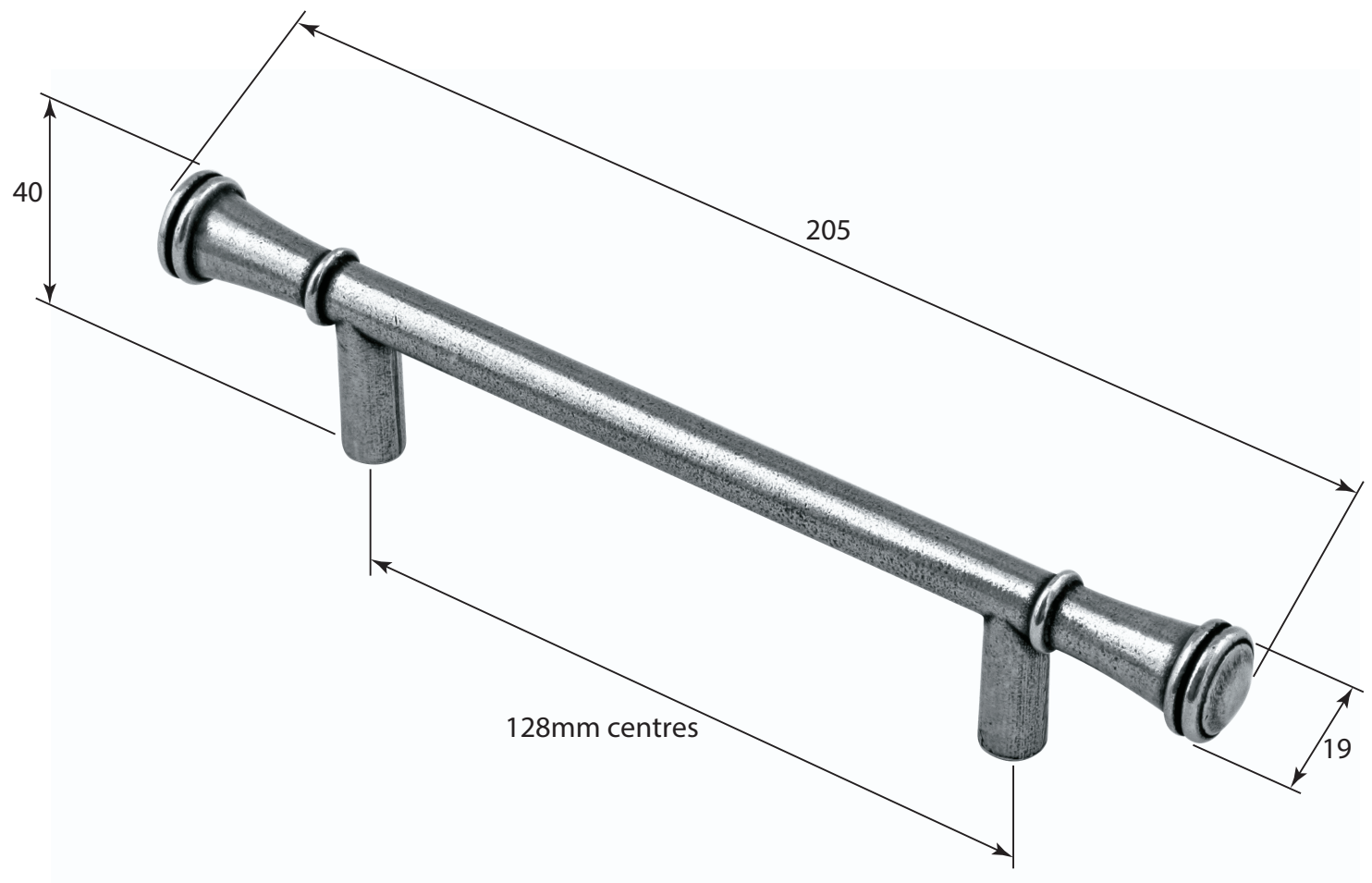

						QTY	
				DESCRIPTION	DRG.	D.Urwin	
				FD537 Durham Pull Handle (128mm centres)	DATE	03/09/18	
1	03/09/18		LT REF.	H:\Finess & Stonebridge Handle Hardware\Finesse\Dim Dwgs\FD537.pdf	SCALE	N/A	
ISSUE	DATE	REVISION	MATL.	Pewter	CODE	FD537	